

Single-Acting Low Flat Cylinders - SFC

Doc. : L1023A Date : 2019/01

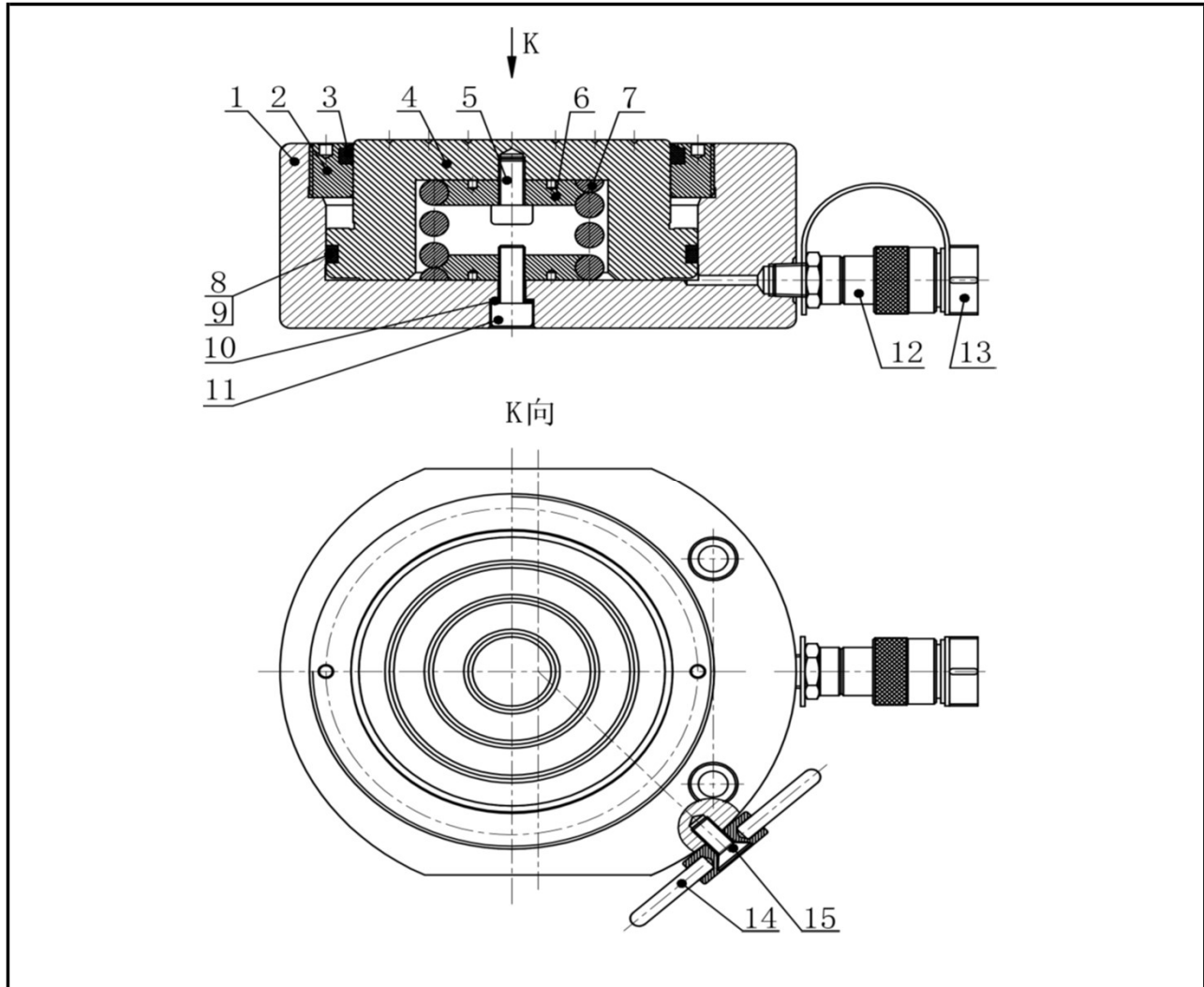

Item NO.	Description	Qty	Part NO.
			SFC100-16
1	Oil cylinder	1	2.001.00295
2	Guide cap	1	2.001.00051
3	J-dustband	1	1.3.001.00020
4	Piston rod	1	2.001.00174
5	Hexagon socket head cap screws	1	●
6	Spring connecting head	2	-
7	Returning spring (Item #6 included)	1	1.3.011.00016
8	Backup Washer	1	●
9	O-ring	1	●
10	Copper gasket	1	●
11	Hexagon socket head cap screws	1	●
12	Female connector	1	1.3.025.00004
13	Connector protective jacket for NPT3/8"	1	1.3.097.00002
14	Hand carry vice (Item #15 included)	1	2.009.00001
15	Inner hexagon countersunk head screws	1	-
●	Repair kit	1	SFC100-16-RK