

Single-Acting Low profile lock-nut Cylinders - SLL

Doc. : L1031A Date : 2019/01

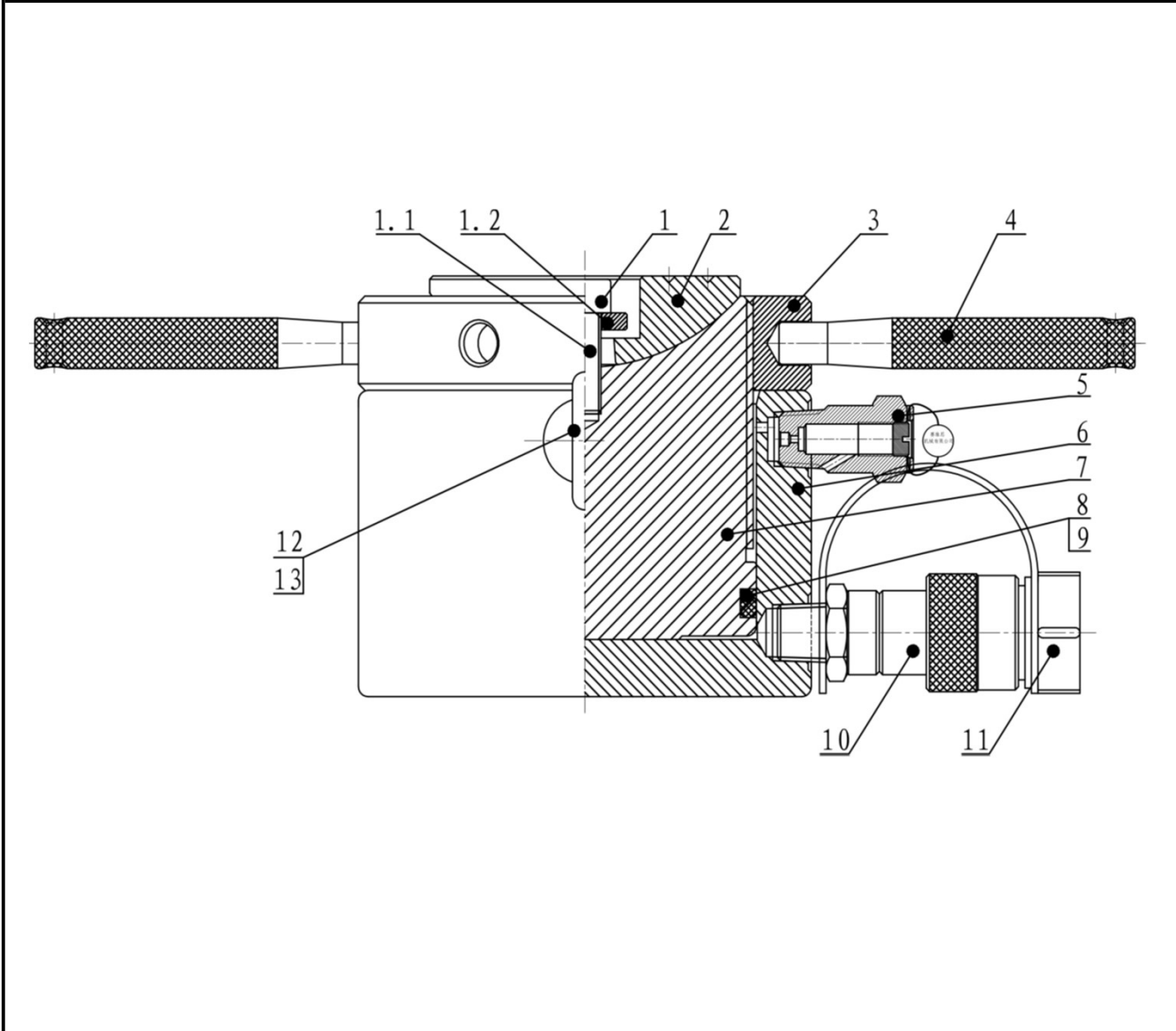

Item NO.	Description	Qty	Part NO.
			SLL500-45
1	Screw components	1	2.025.00004
1.1	Hexagon socket head cap screws M10x40	1	1.3.027.00056
1.2	Washer	1	2.001.00871
2	Lifting head	1	2.001.02735
3	Lock ring	1	2.001.02736
4	Handle	1	2.001.00876
5	Trip Limit valve	1	2.008.00050
6	Oil cylinder	1	2.001.02737
7	Piston rod	1	2.001.02738
8	Backup Washer 290x305x2.5	1	1.3.007.00217
9	O- ring 287.8x8.6	1	1.3.002.00343
10	Female connector	1	1.3.025.00004
11	Connector protective jacket for NPT3/8"	1	1.3.097.00002
12	Lifting bolt M20	2	1.3.009.00002
13	Hexagon nut M20	2	1.3.071.00004