

Double-Acting Hollow Cylinders - DHC series

Doc. : L1033A Date : 2018/12

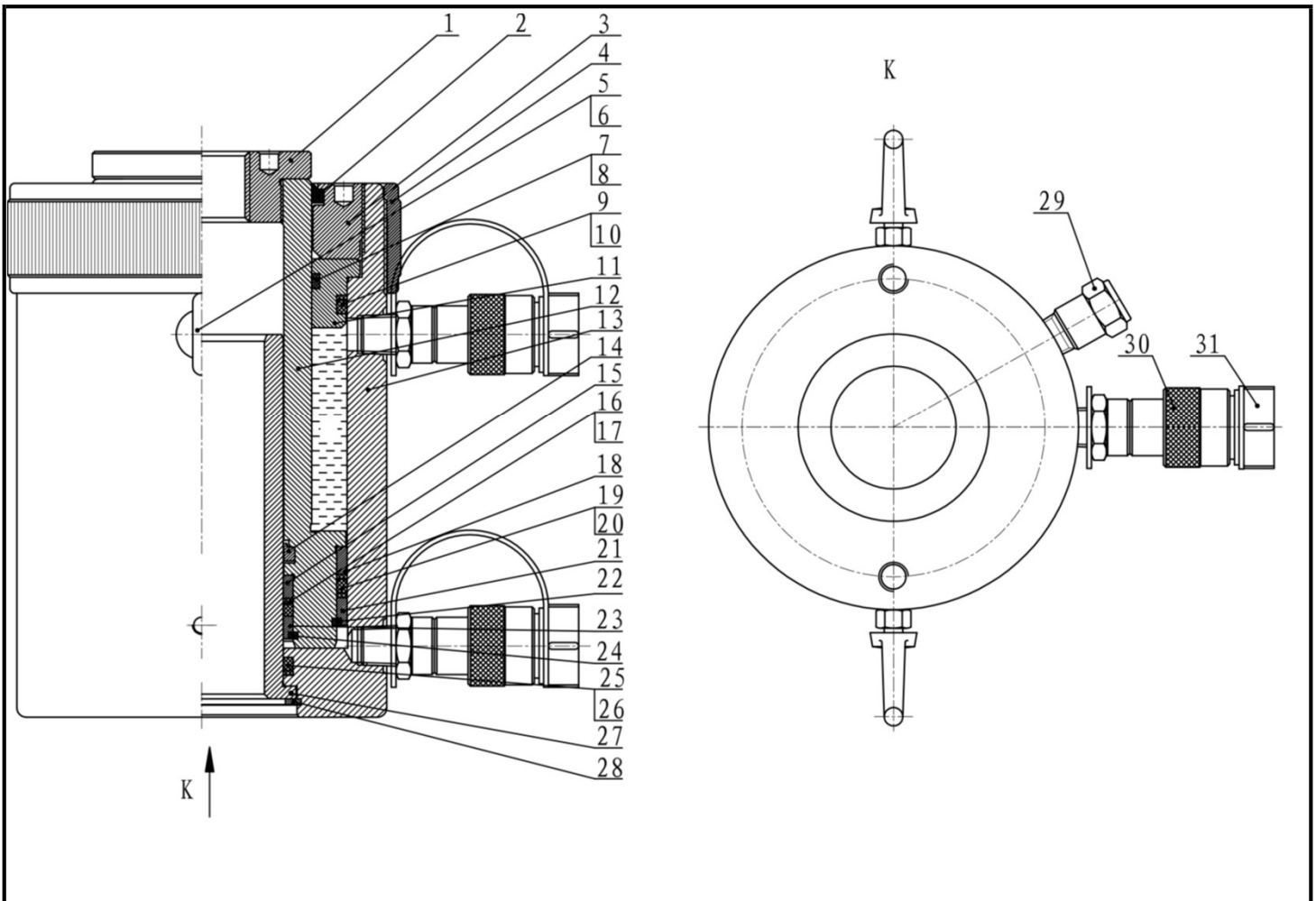

Item NO.	Description	Qty	Part NO.
			DHC 300-258
1	Lifting head	1	2.001.02127
2	J-dustband	1	1.3.001.00027
3	Guide cap	1	2.001.02922
4	Thread protector	1	2.001.02134
5	Lifting bolt (Item #6 included)	2	1.3.009.00005
6	Hexagon nut	2	-
7	Backup Washer	1	●
8	O- ring	1	●
9	Backup Washer	1	●
10	O- ring	1	●
11	Front guide ring	1	●
12	Piston rod	1	2.001.03306
13	Oil cylinder	1	2.001.03305
14	J-dustband	1	1.3.001.00031
15	Front the inner guide ring	1	2.001.03309
16	Backup Washer	1	●
17	O- ring	1	●
18	Front guide sleeve	1	2.001.03307
19	Backup Washer	2	●
20	O- ring	1	●
21	Back the guide sleeve	1	●
22	Semi-ring	1	2.001.02929
23	Back the inner guide sleeve	1	2.001.03310
24	Inner semi-ring	1	2.001.02931
25	Backup Washer	1	●
26	O- ring	1	●
27	Centre hole	1	2.001.03311
28	Circlips for holes	1	1.3.017.00014
29	Safety valve	1	●
30	Female connector	2	1.3.025.00004
31	Connector protective jacket for NPT3/8"	2	1.3.097.00002
●	Repair kit	1	DHC 300-258-RK