

Double-Acting Hollow Cylinders - DHC series

Doc. : L1034A Date : 2018/12

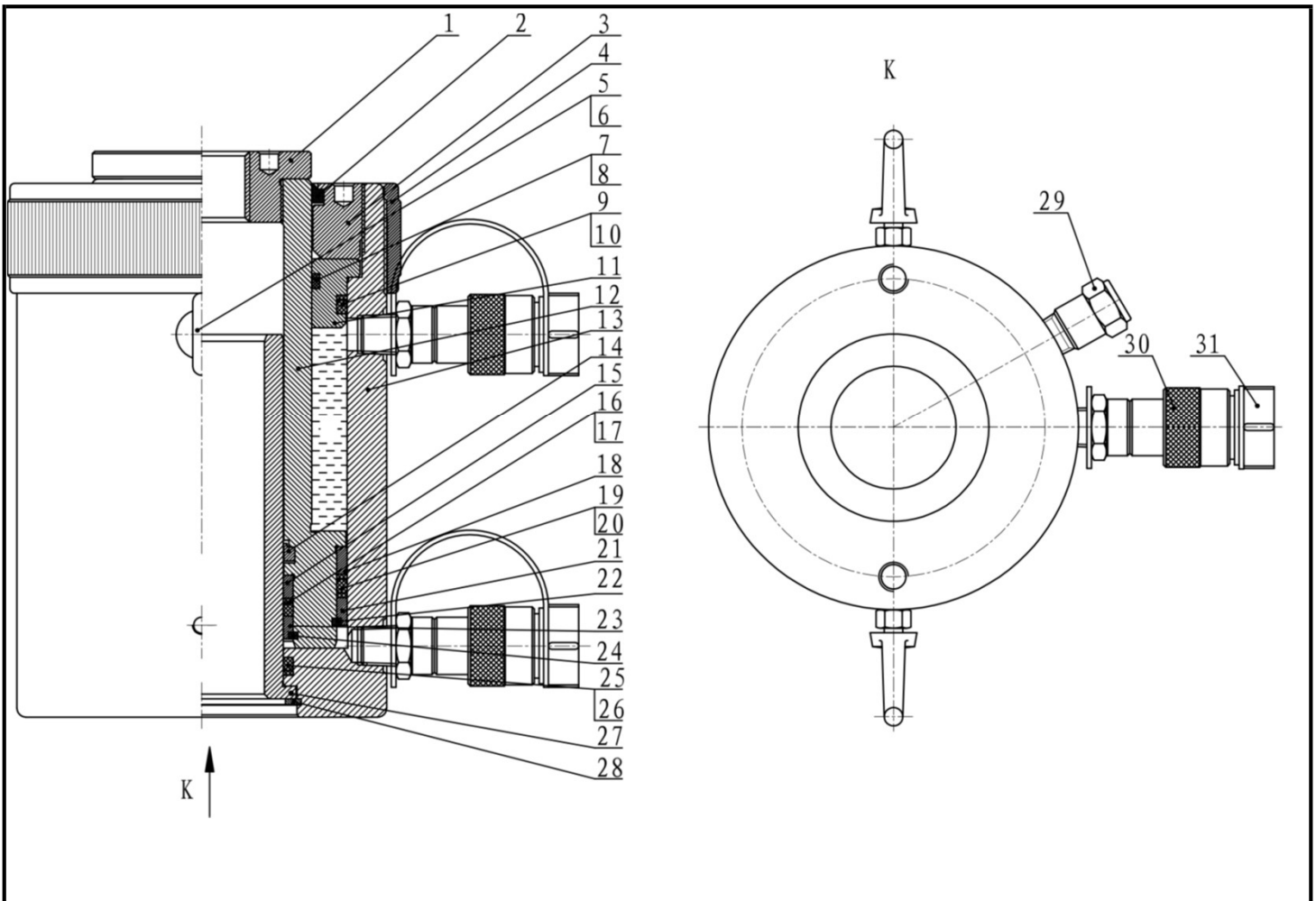

Item NO.	Description	Qty	Part NO.
			DHC 600-89
1	Lifting head	1	2.001.00588
2	J-dustband	1	1.3.001.00032
3	Guide cap	1	2.001.02880
4	Thread protector	1	2.001.02139
5	Lifting bolt (Item #6 included)	2	1.3.009.00005
6	Hexagon nut	2	-
7	Backup Washer	1	●
8	O- ring	1	●
9	Backup Washer	1	●
10	O- ring	1	●
11	Front guide ring	1	●
12	Piston rod	1	2.001.03303
13	Oil cylinder	1	2.001.03302
14	J-dustband	1	1.3.010.00003
15	Front the inner guide ring	1	2.001.02884
16	Backup Washer	1	●
17	O- ring	1	●
18	Front guide sleeve	1	2.001.02885
19	Backup Washer	2	●
20	O- ring	1	●
21	Back the guide sleeve	1	●
22	Semi-ring	1	2.001.02887
23	Back the inner guide sleeve	1	2.001.02888
24	Inner semi-ring	1	2.001.02889
25	Backup Washer	1	●
26	O- ring	1	●
27	Centre hole	1	2.001.03304
28	Circlips for holes	1	1.3.017.00015
29	Safety valve	1	●
30	Female connector	2	1.3.025.00004
31	Connector protective jacket for NPT3/8"	2	1.3.097.00002
●	Repair kit	1	DHC 600-89-RK